

# BFP420

## Surface mount wideband silicon NPN RF bipolar transistor



### Product description

The BFP420 is a low noise device based on a grounded emitter (SIEGET™) that is part of Infineon’s established fourth generation RF bipolar transistor family. Its transition frequency  $f_T$  of 25 GHz, high gain and low current characteristics make the device suitable for oscillators up to 10 GHz. It remains cost competitive without compromising on ease of use.



### Feature list

- Minimum noise figure  $NF_{min} = 1.1$  dB at 1.8 GHz, 2 V, 5 mA
- High gain  $G_{ms} = 21$  dB at 1.8 GHz, 2 V, 20 mA
- $OIP_3 = 22$  dBm at 1.8 GHz, 2 V, 20 mA

### Product validation

Qualified for industrial applications according to the relevant tests of JEDEC47/20/22.

### Potential applications

- Radio-frequency oscillators
- Broadband low noise amplifiers (LNAs) for CATV, DVB-T, DAB/DMB and FM/AM radio
- LNAs for sub-1 GHz ISM band applications

### Device information

Product name / Ordering code	Package	Pin configuration				Marking	Pieces / Reel
BFP420 / BFP420H6327XTSA1	SOT343	1 = B	2 = E	3 = C	4 = E	AMs	3000
BFP420 / BFP420H6433XTMA1							10000

**Attention:** ESD (Electrostatic discharge) sensitive device, observe handling precautions

## Table of contents

	<b>Product description</b> .....	1
	<b>Feature list</b> .....	1
	<b>Product validation</b> .....	1
	<b>Potential applications</b> .....	1
	<b>Device information</b> .....	1
	<b>Table of contents</b> .....	2
<b>1</b>	<b>Absolute maximum ratings</b> .....	3
<b>2</b>	<b>Thermal characteristics</b> .....	4
<b>3</b>	<b>Electrical characteristics</b> .....	6
3.1	DC characteristics .....	6
3.2	General AC characteristics .....	6
3.3	Frequency dependent AC characteristics .....	7
3.4	Characteristic DC diagrams .....	8
3.5	Characteristic AC diagrams .....	11
<b>4</b>	<b>Package information SOT343</b> .....	16
	<b>Revision history</b> .....	17
	<b>Disclaimer</b> .....	18

**Absolute maximum ratings**

**1 Absolute maximum ratings**

**Table 1 Absolute maximum ratings at  $T_A = 25\text{ °C}$  (unless otherwise specified)**

Parameter	Symbol	Values		Unit	Note or test condition	
		Min.	Max.			
Collector emitter voltage	$V_{CEO}$	-	4.5	V	Open base	
			4.1		$T_A = -55\text{ °C}$ , open base	
Collector emitter voltage	$V_{CES}$		15		E-B short circuited	
Collector base voltage	$V_{CBO}$		15		Open emitter	
Emitter base voltage	$V_{EBO}$		1.5		Open collector	
Base current	$I_B$		9		mA	-
Collector current	$I_C$		60			
Total power dissipation <sup>1)</sup>	$P_{tot}$		210	mW	$T_S \leq 98\text{ °C}$	
Junction temperature	$T_J$		150	°C	-	
Storage temperature	$T_{Stg}$	-55				

**Attention:** *Stresses above the max. values listed here may cause permanent damage to the device. Exposure to absolute maximum rating conditions for extended periods may affect device reliability. Exceeding only one of these values may cause irreversible damage to the integrated circuit.*

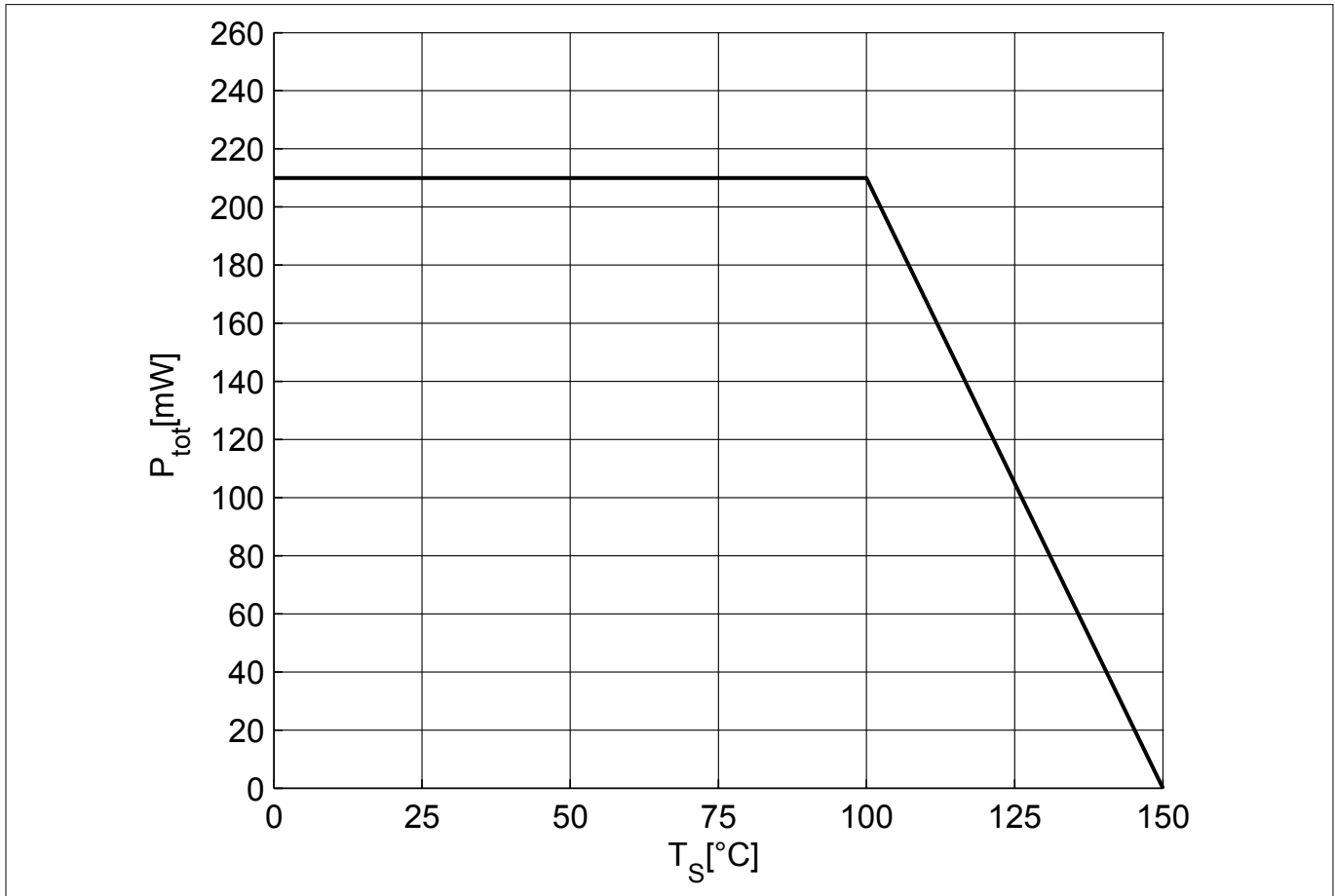
<sup>1</sup>  $T_S$  is the soldering point temperature.  $T_S$  is measured on the emitter lead at the soldering point of the PCB.

Thermal characteristics

## 2 Thermal characteristics

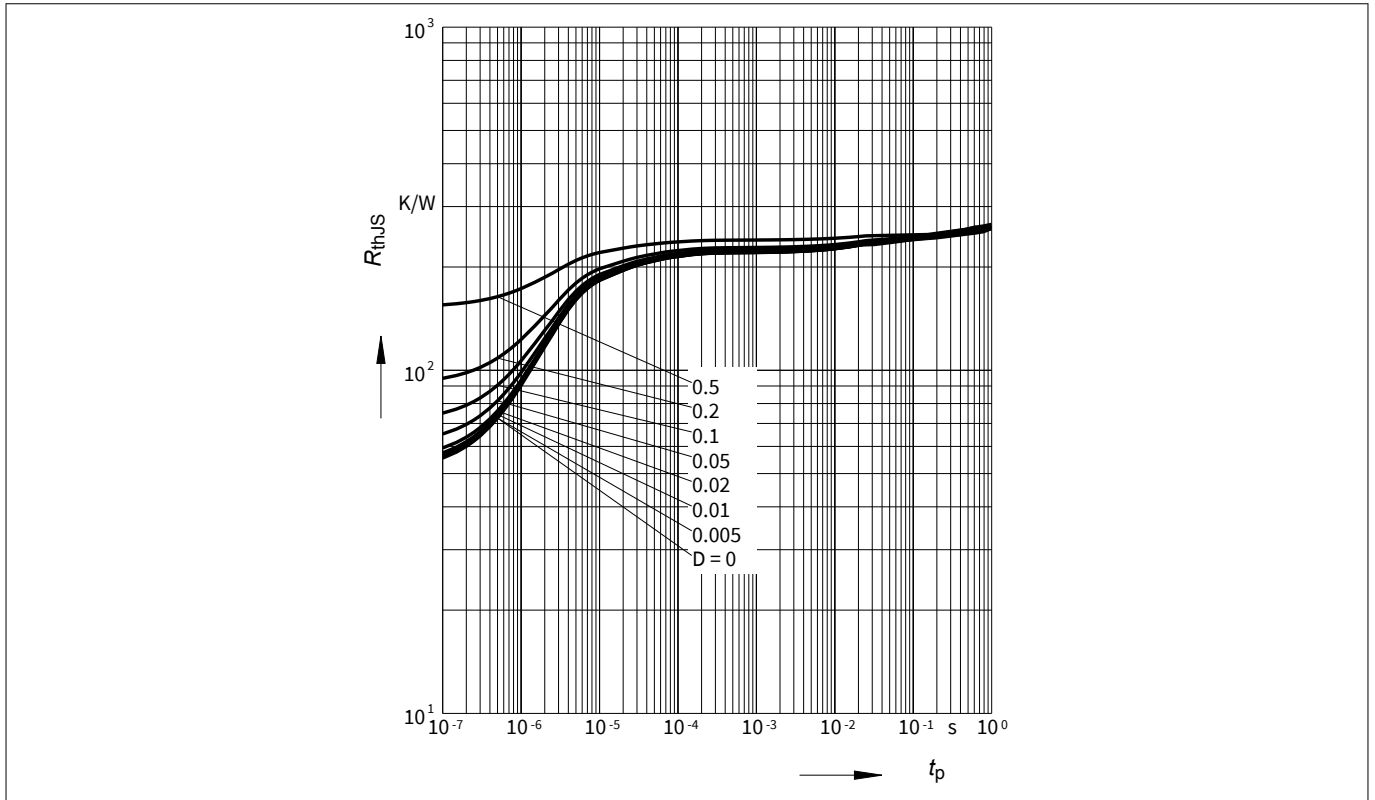
**Table 2 Thermal resistance**

Parameter	Symbol	Values			Unit	Note or test condition
		Min.	Typ.	Max.		
Junction - soldering point	$R_{thJS}$	-	250	-	K/W	-

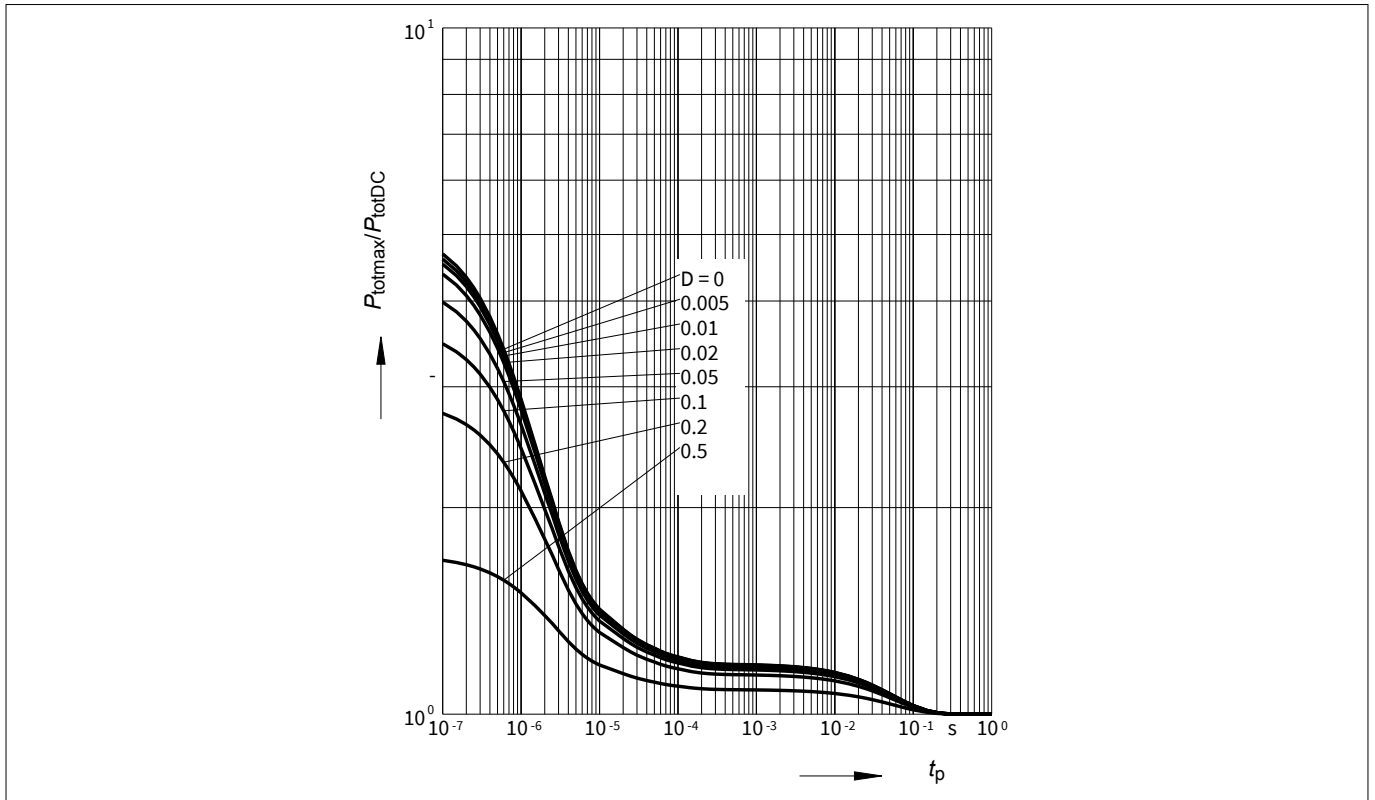


**Figure 1 Total power dissipation  $P_{tot} = f(T_S)$**

**Thermal characteristics**



**Figure 2** Permissible pulse load  $R_{thJS} = f(t_p)$



**Figure 3** Permissible pulse load  $P_{tot,max} / P_{tot,DC} = f(t_p)$

**Electrical characteristics**

**3 Electrical characteristics**

**3.1 DC characteristics**

**Table 3 DC characteristics at  $T_A = 25\text{ °C}$**

Parameter	Symbol	Values			Unit	Note or test condition
		Min.	Typ.	Max.		
Collector emitter breakdown voltage	$V_{(BR)CEO}$	4.5	5	–	V	$I_C = 1\text{ mA}$ , $I_B = 0$ , open base
Collector emitter leakage current	$I_{CES}$	–	–	10 <sup>2)</sup>	μA	$V_{CE} = 15\text{ V}$ , $V_{BE} = 0$ , E-B short circuited
Collector base leakage current	$I_{CBO}$			100 <sup>2)</sup>	nA	$V_{CB} = 5\text{ V}$ , $I_E = 0$ , open emitter
Emitter base leakage current	$I_{EBO}$			3 <sup>2)</sup>	μA	$V_{EB} = 0.5\text{ V}$ , $I_C = 0$ , open collector
DC current gain	$h_{FE}$	60	95	130		$V_{CE} = 4\text{ V}$ , $I_C = 20\text{ mA}$ , pulse measured

**3.2 General AC characteristics**

**Table 4 General AC characteristics at  $T_A = 25\text{ °C}$**

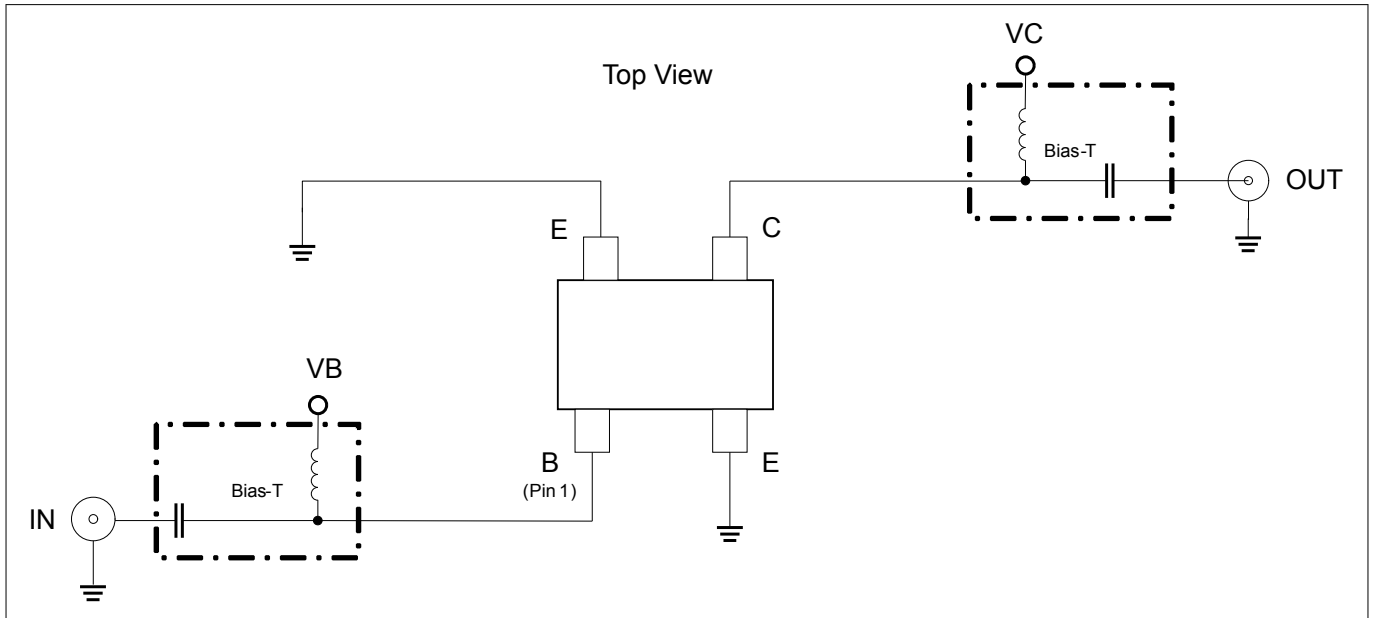
Parameter	Symbol	Values			Unit	Note or test condition
		Min.	Typ.	Max.		
Transition frequency	$f_T$	18	25	–	GHz	$V_{CE} = 3\text{ V}$ , $I_C = 30\text{ mA}$ , $f = 2\text{ GHz}$
Collector base capacitance	$C_{CB}$	–	0.15	0.3	pF	$V_{CB} = 2\text{ V}$ , $V_{BE} = 0$ , $f = 1\text{ MHz}$ , emitter grounded
Collector emitter capacitance	$C_{CE}$		0.37	–		$V_{CE} = 2\text{ V}$ , $V_{BE} = 0$ , $f = 1\text{ MHz}$ , base grounded
Emitter base capacitance	$C_{EB}$		0.55			$V_{EB} = 0.5\text{ V}$ , $V_{CB} = 0$ , $f = 1\text{ MHz}$ , collector grounded

<sup>2</sup> Maximum values not limited by the device but by the short cycle time of the 100% test.

**Electrical characteristics**

**3.3 Frequency dependent AC characteristics**

Measurement setup is a test fixture with Bias-T's in a 50 Ω system,  $T_A = 25\text{ °C}$ .



**Figure 4 Testing circuit**

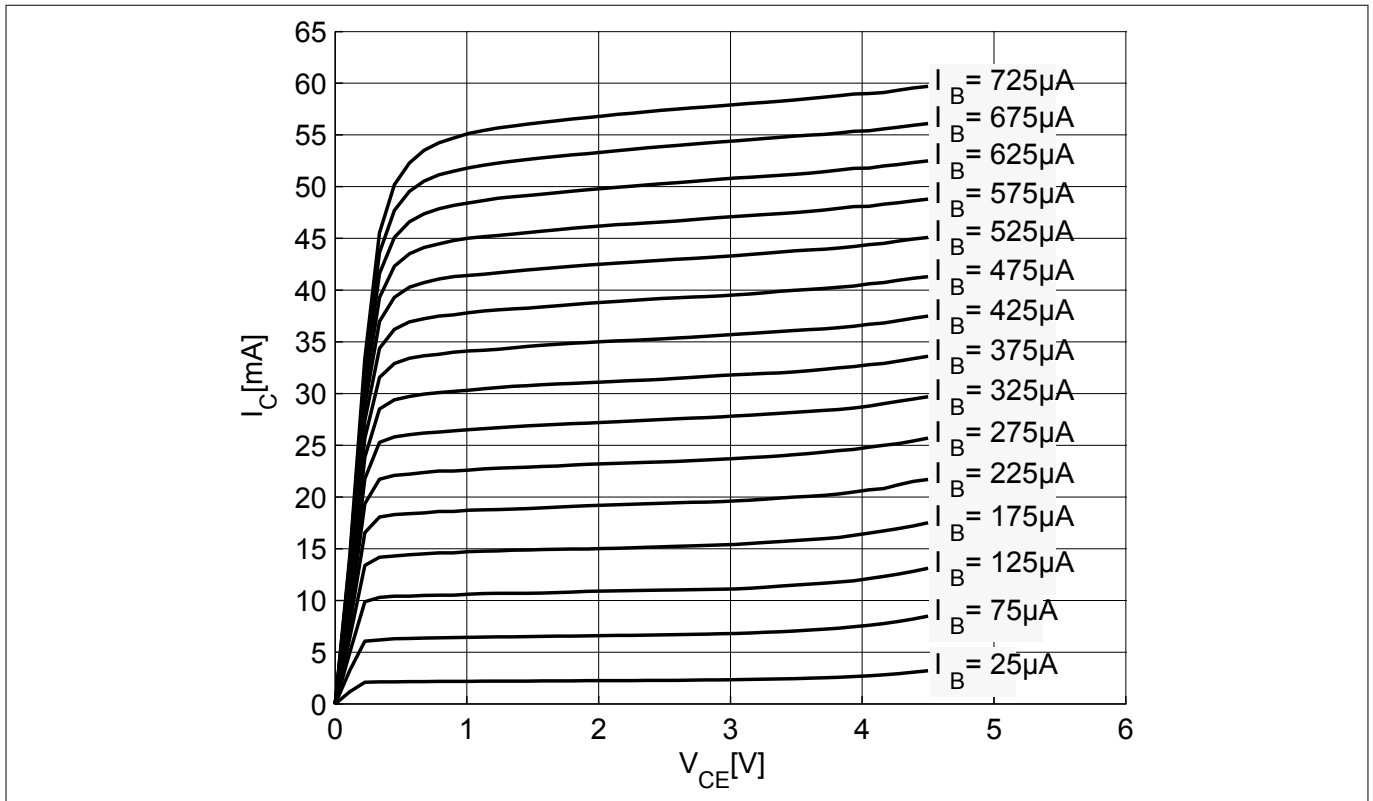
**Table 5 AC characteristics,  $V_{CE} = 2\text{ V}$ ,  $f = 1.8\text{ GHz}$**

Parameter	Symbol	Values			Unit	Note or test condition
		Min.	Typ.	Max.		
Power gain					dB	$I_C = 20\text{ mA}$
<ul style="list-style-type: none"> <li>Maximum power gain</li> <li>Transducer gain</li> </ul>	$G_{ms}$ $ S_{21} ^2$	– 14	21 17	–		
Noise figure					dBm	$I_C = 5\text{ mA}$
<ul style="list-style-type: none"> <li>Minimum noise figure</li> </ul>	$NF_{min}$	–	1.1	–		
Linearity					dBm	$I_C = 20\text{ mA}$ , $Z_S = Z_L = 50\text{ }\Omega$
<ul style="list-style-type: none"> <li>3rd order intercept point at output</li> <li>1 dB gain compression point at output</li> </ul>	$OIP_3$ $OP_{1dB}$		22 12			

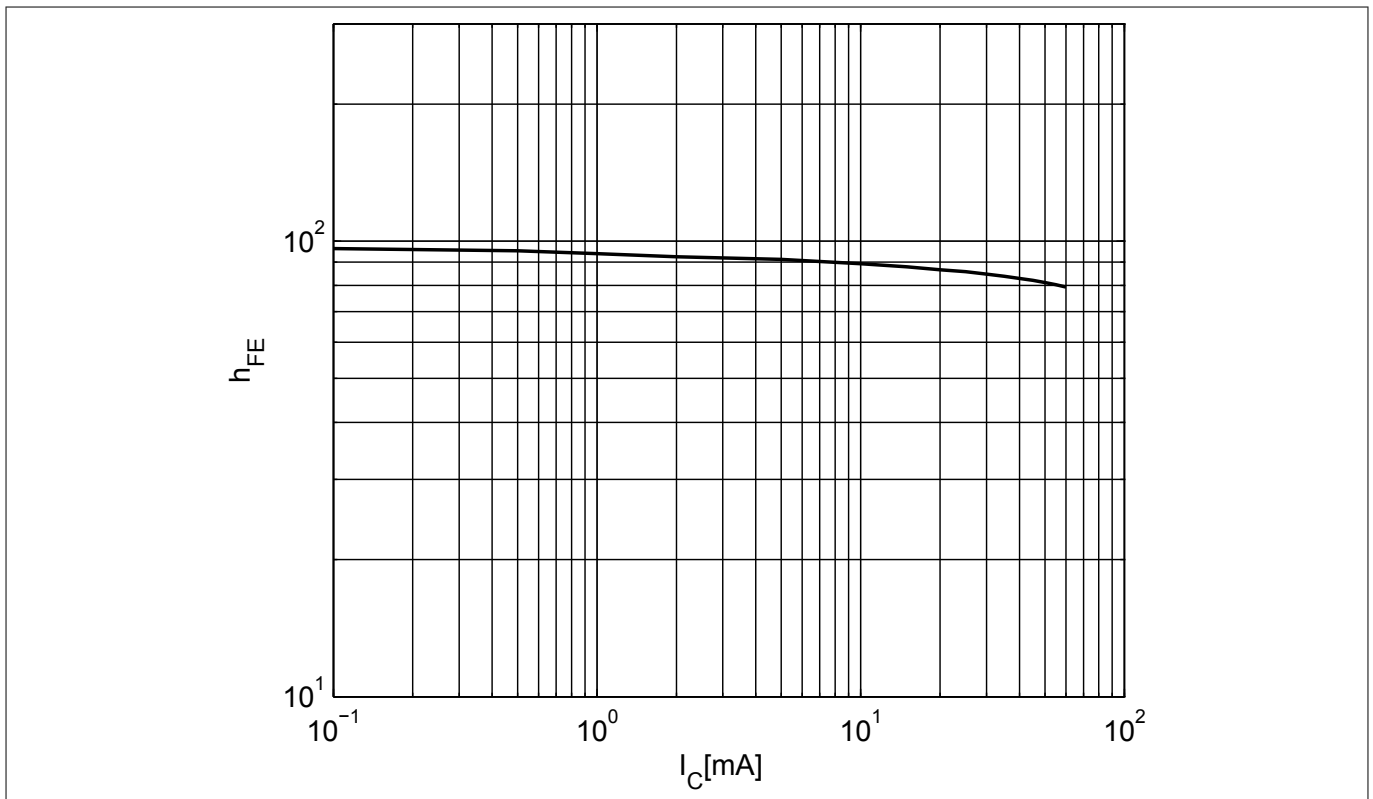
*Note:*  $G_{ms} = |S_{21}/S_{12}|$  for  $k < 1$ ;  $G_{ma} = |S_{21}/S_{12}|(k-(k^2-1)^{1/2})$  for  $k > 1$ . In order to get the  $NF_{min}$  values stated in this chapter, the test fixture losses have been subtracted from all measured results.  $OIP_3$  value depends on termination of all intermodulation frequency components. Termination used for this measurement is 50 Ω from 0.1 MHz to 6 GHz.

**Electrical characteristics**

**3.4 Characteristic DC diagrams**



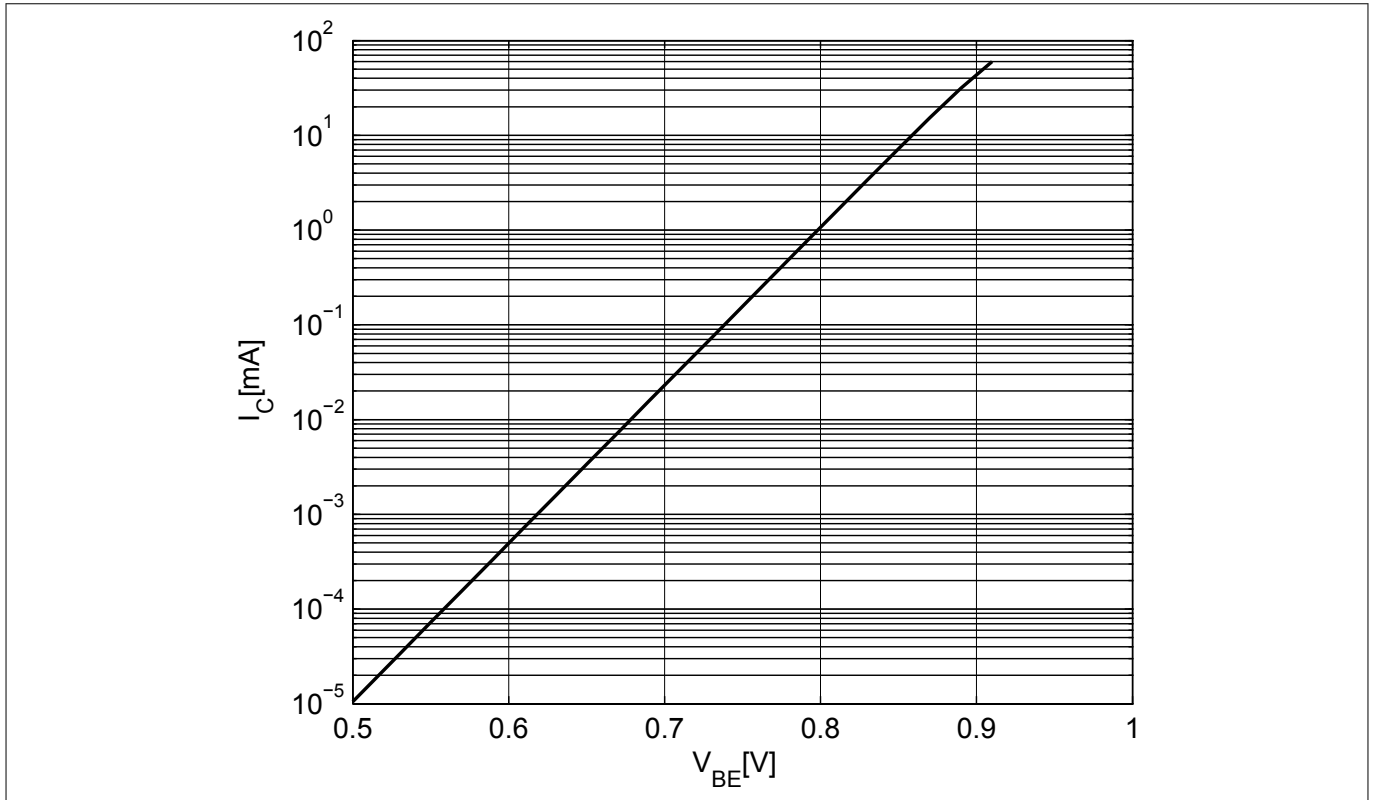
**Figure 5 Collector current vs. collector emitter voltage  $I_C = f(V_{CE})$ ,  $I_B = \text{parameter}$**



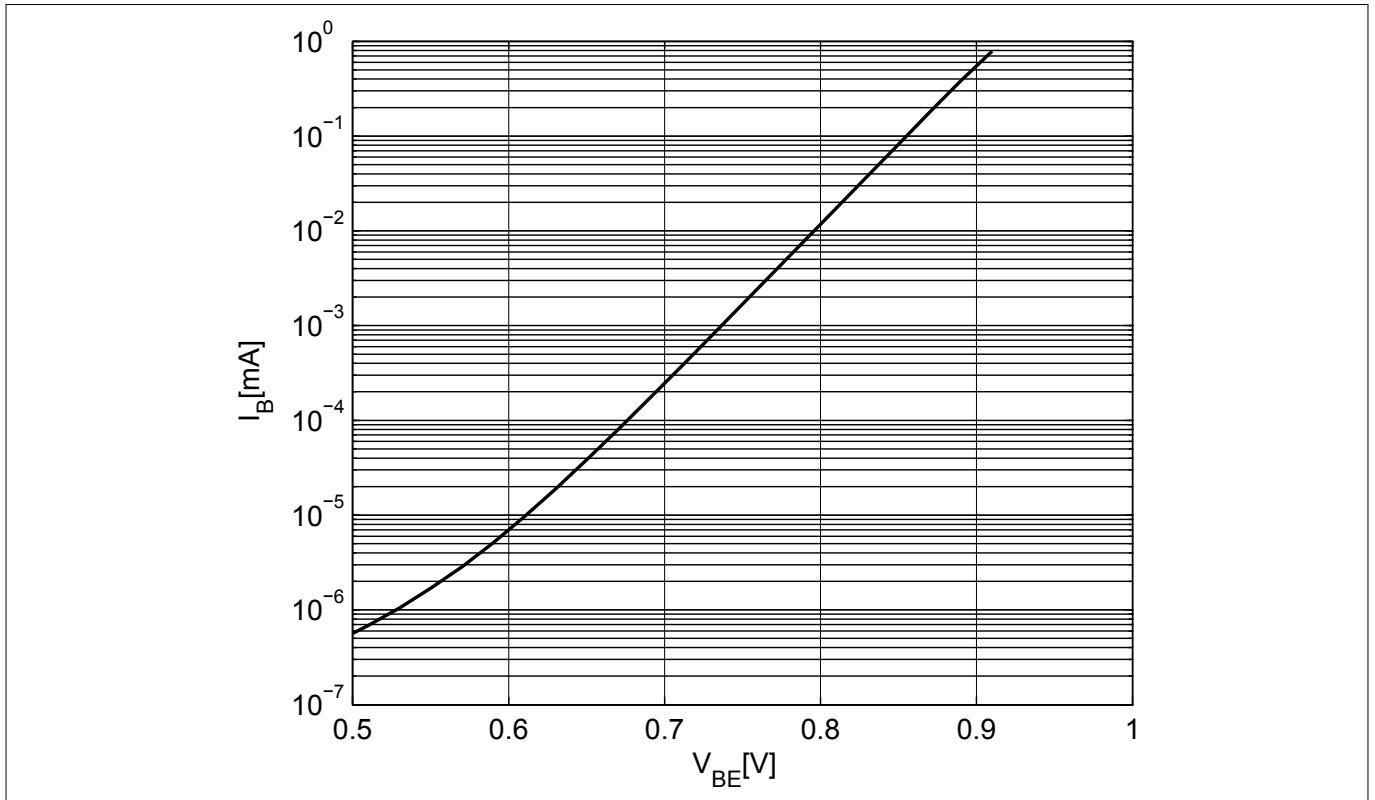
**Figure 6 DC current gain  $h_{FE} = f(I_C)$ ,  $V_{CE} = 3 \text{ V}$**



**Electrical characteristics**

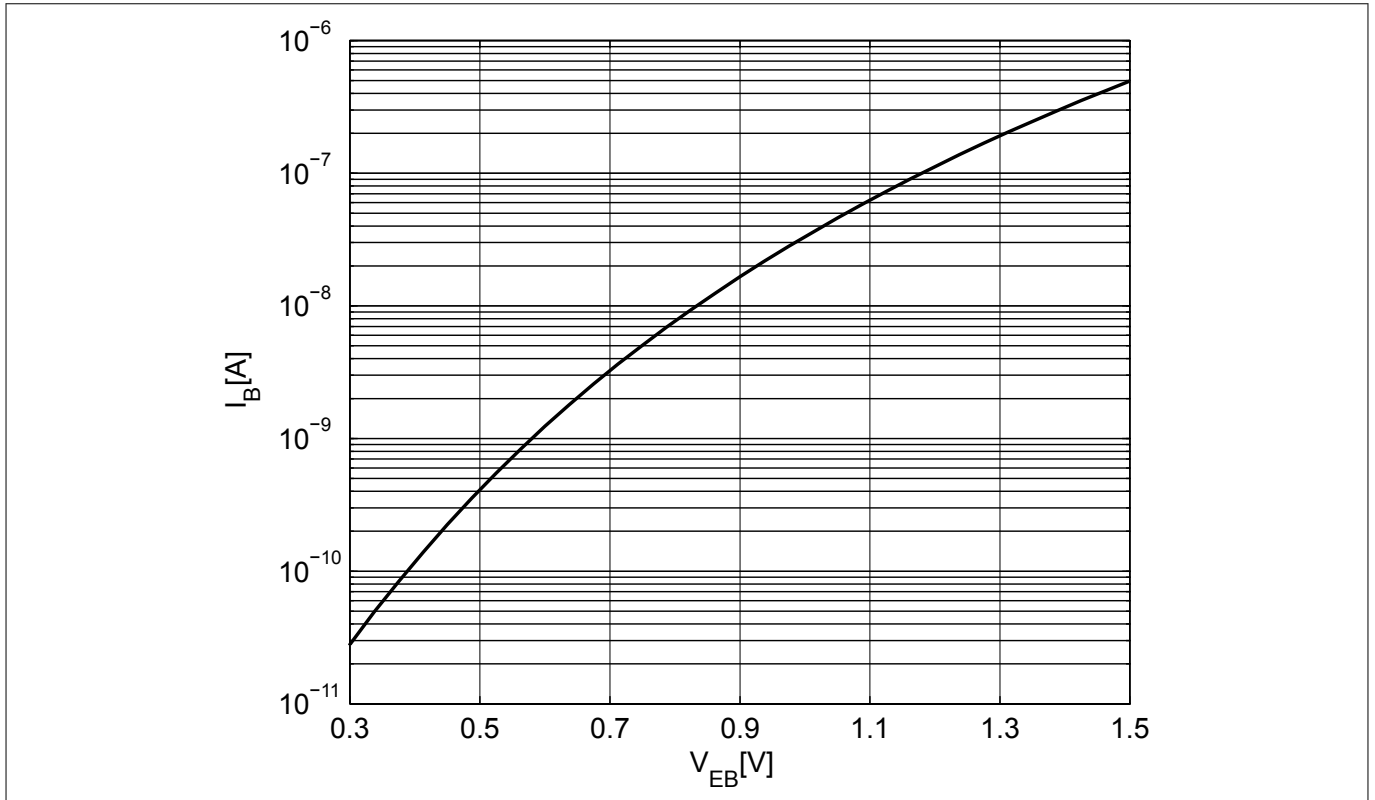


**Figure 7** Collector current vs. base emitter forward voltage  $I_C = f(V_{BE})$ ,  $V_{CE} = 3\text{ V}$

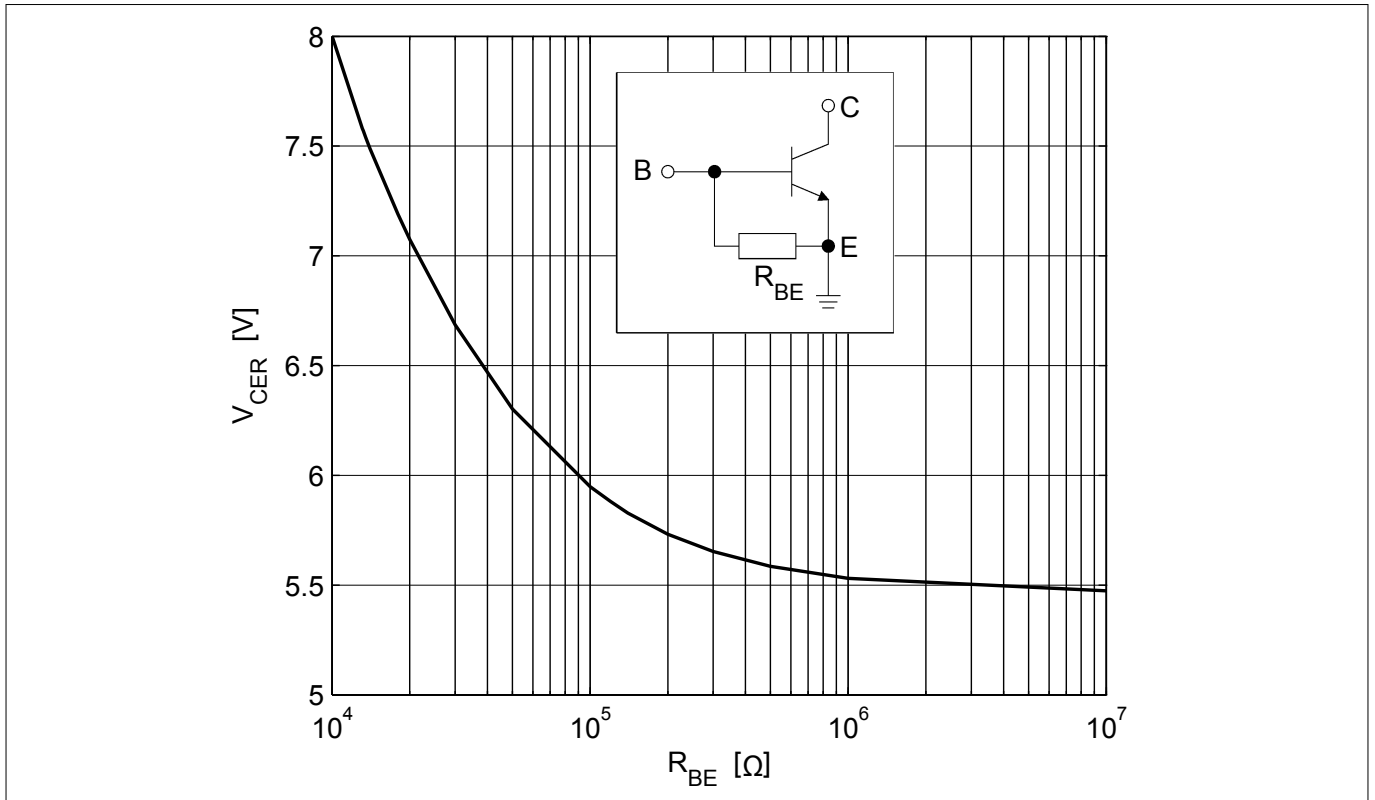


**Figure 8** Base current vs. base emitter forward voltage  $I_B = f(V_{BE})$ ,  $V_{CE} = 3\text{ V}$

**Electrical characteristics**



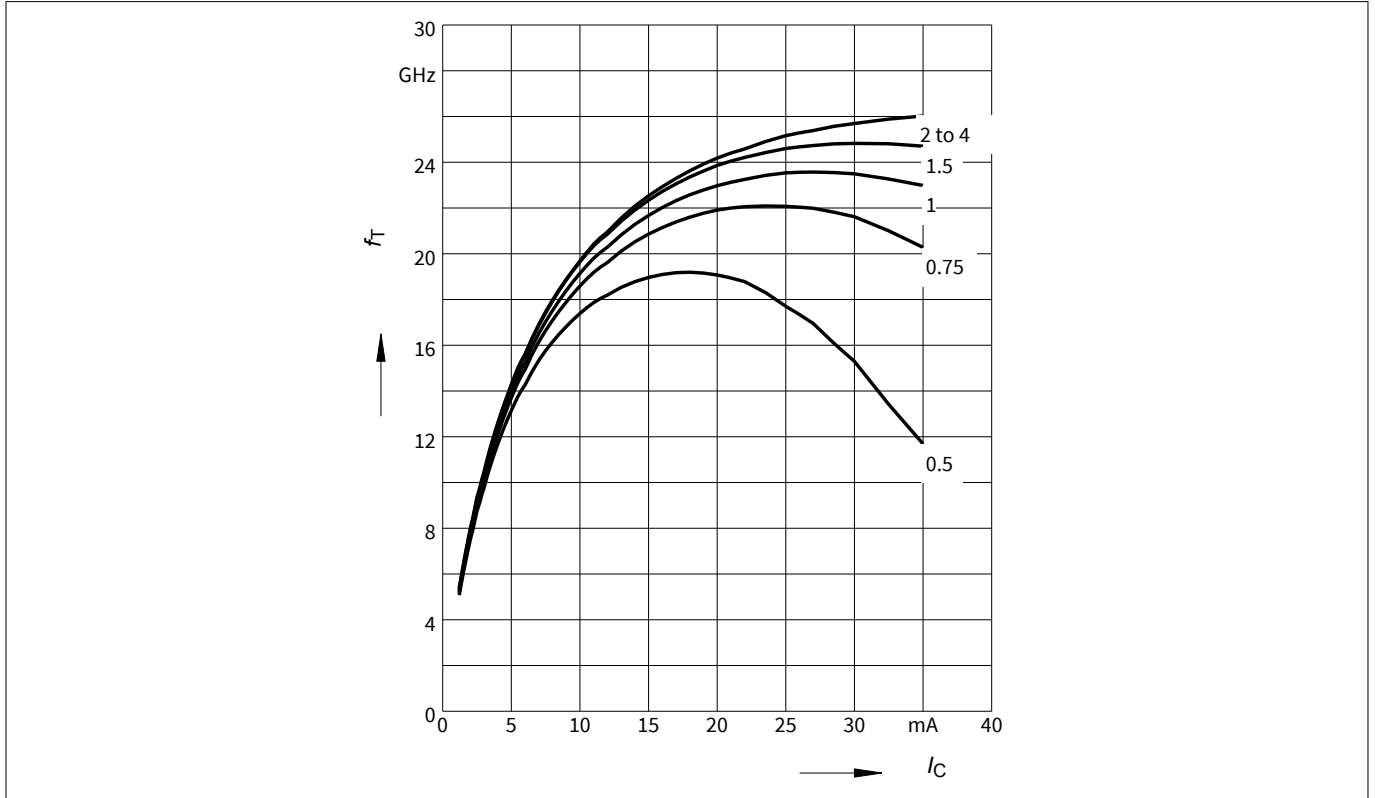
**Figure 9** Base current vs. base emitter reverse voltage  $I_B = f(V_{EB})$ ,  $V_{CE} = 3\text{ V}$



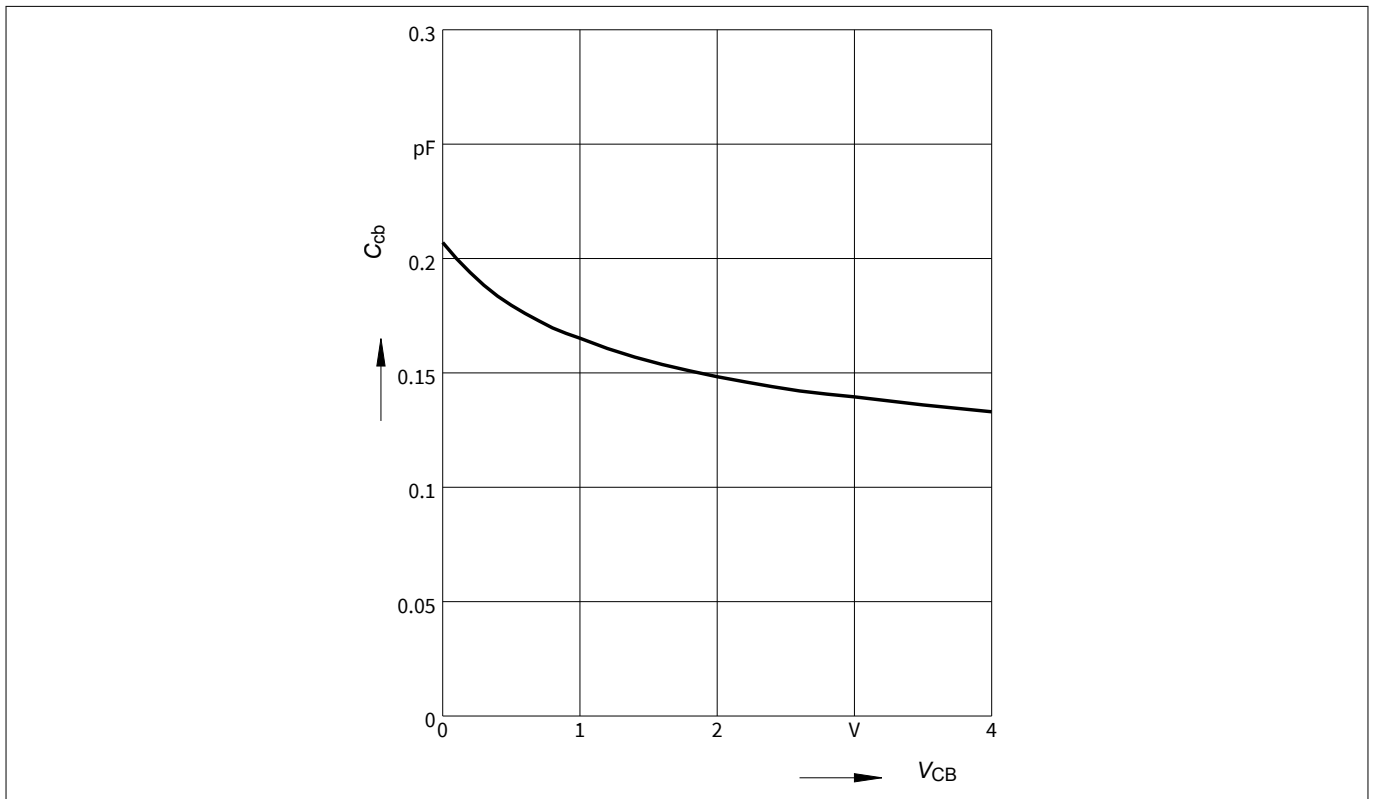
**Figure 10** Collector emitter breakdown voltage  $V_{CER} = f(R_{BE})$ ,  $I_C = 1\text{ mA}$

**Electrical characteristics**

**3.5 Characteristic AC diagrams**

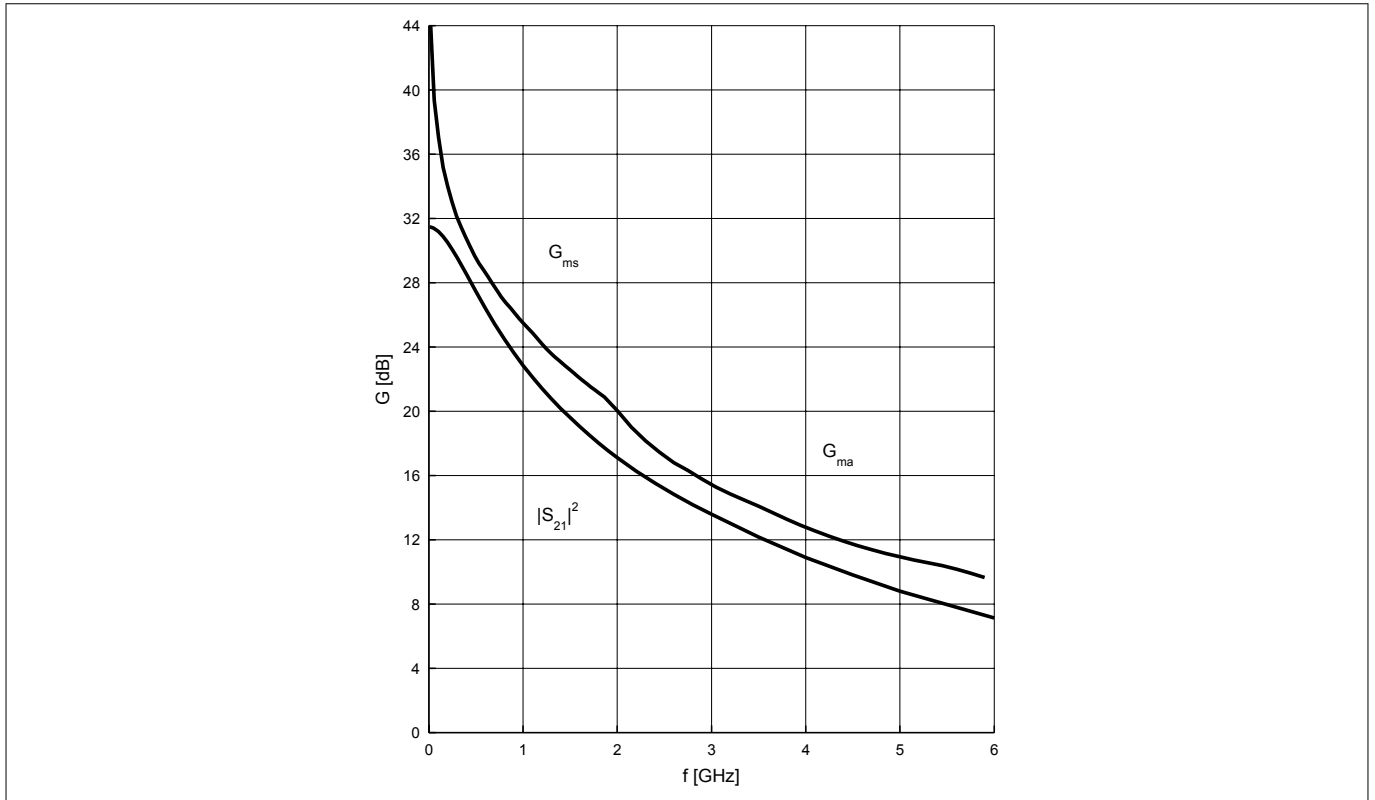


**Figure 11** Transition frequency  $f_T = f(I_C)$ ,  $f = 2 \text{ GHz}$ ,  $V_{CE} = \text{parameter}$

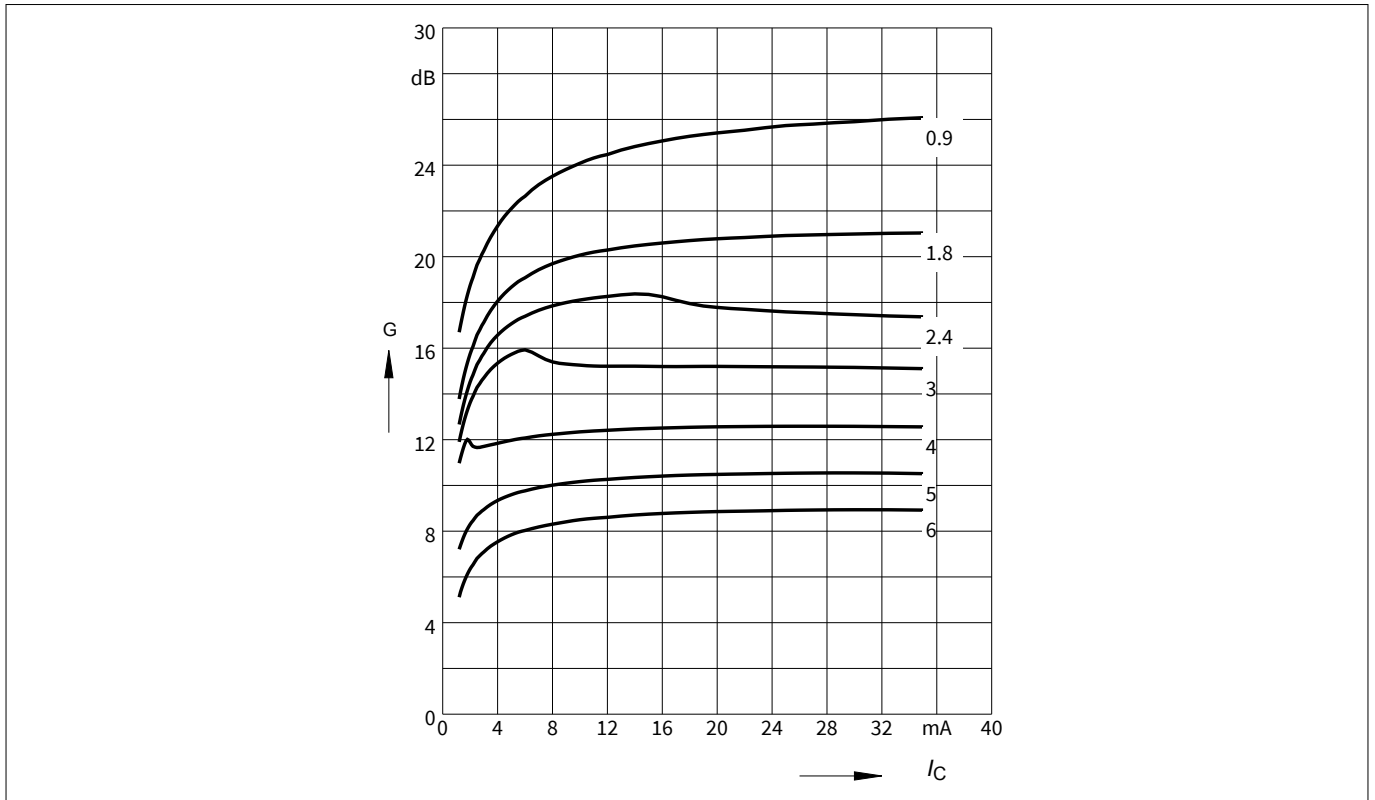


**Figure 12** Collector base capacitance  $C_{CB} = f(V_{CB})$ ,  $f = 1 \text{ MHz}$

**Electrical characteristics**

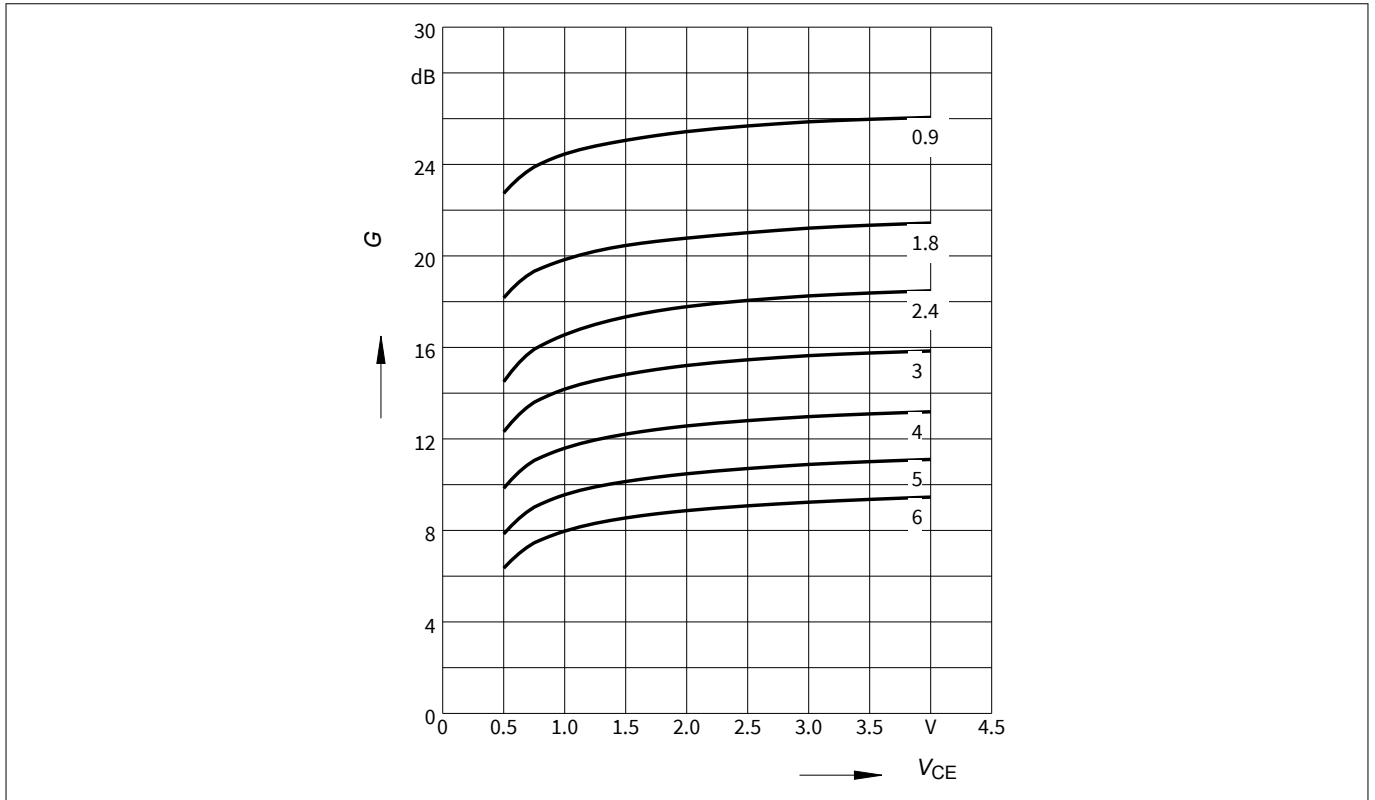


**Figure 13** Gain  $G_{ma}$ ,  $G_{ms}$ ,  $|S_{21}|^2 = f(f)$ ,  $V_{CE} = 2\text{ V}$ ,  $I_C = 20\text{ mA}$

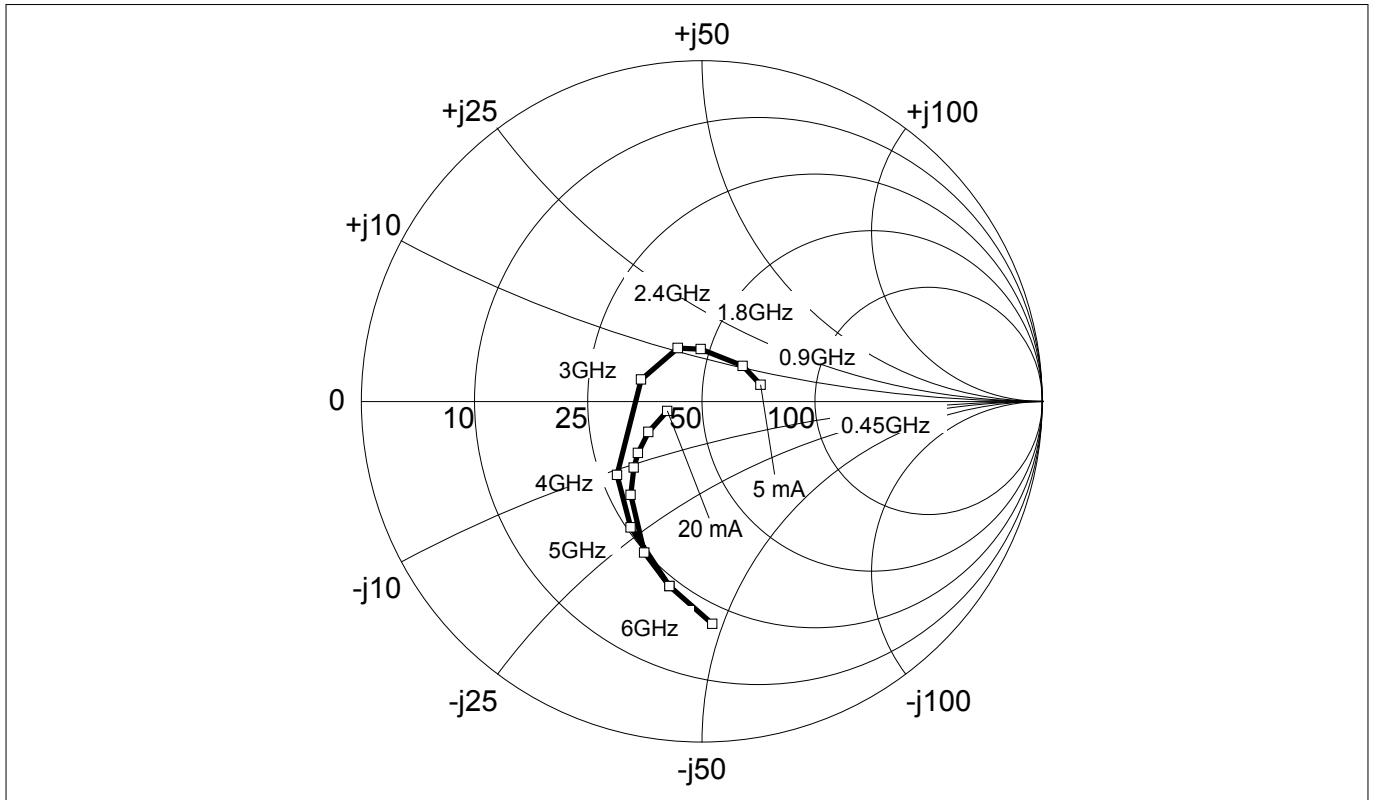


**Figure 14** Maximum power gain  $G_{max} = f(I_C)$ ,  $V_{CE} = 2\text{ V}$ ,  $f = \text{parameter in GHz}$

**Electrical characteristics**

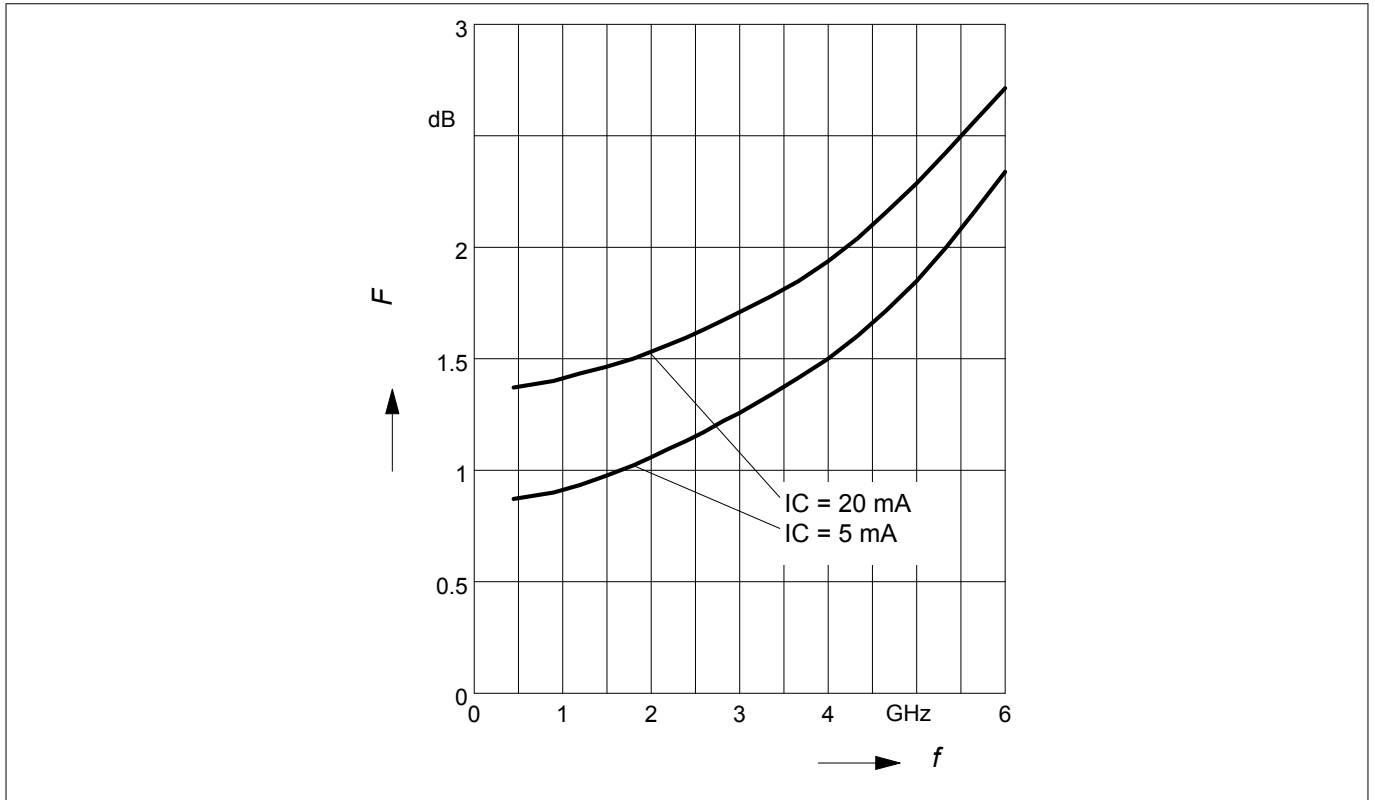


**Figure 15** Maximum power gain  $G_{max} = f(V_{CE})$ ,  $I_C = 20 \text{ mA}$ ,  $f = \text{parameter in GHz}$

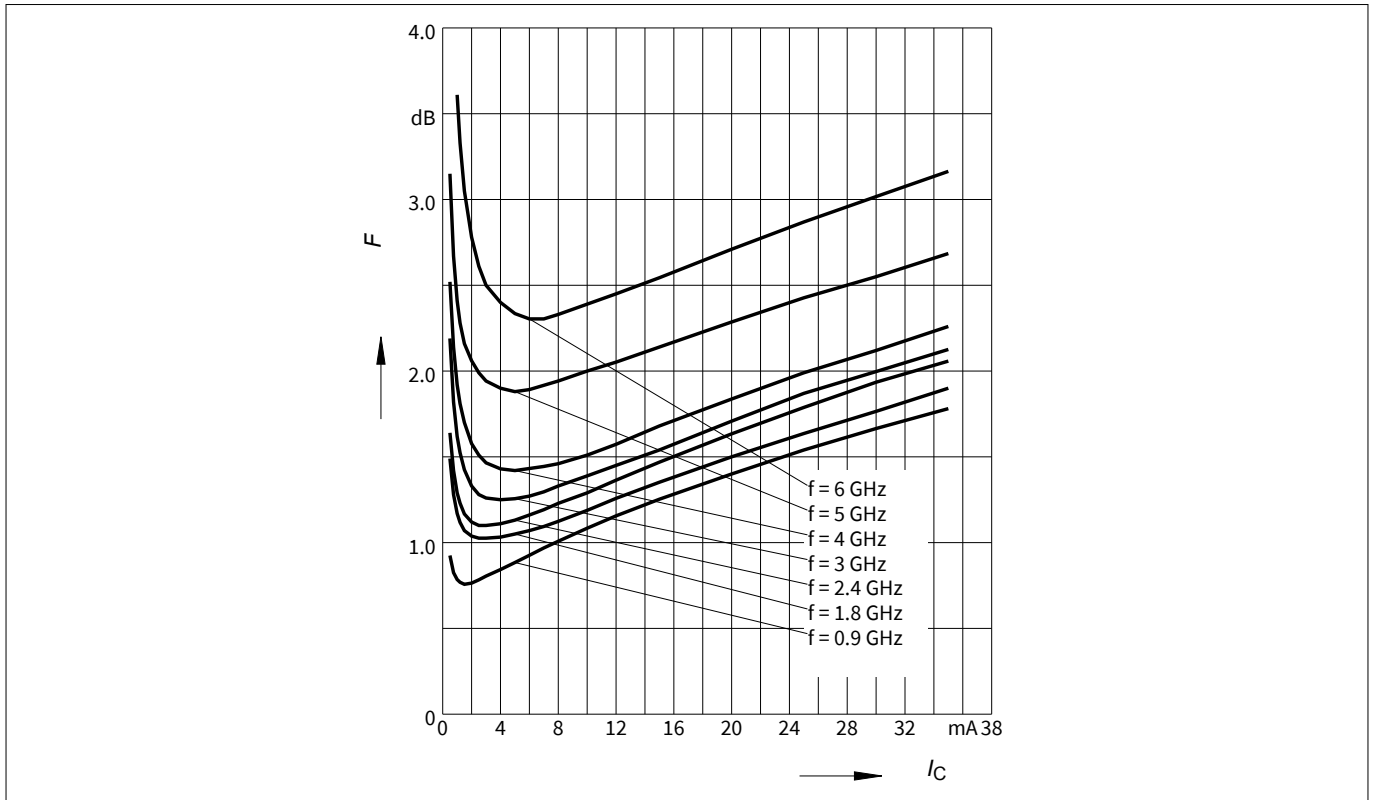


**Figure 16** Source impedance for minimum noise figure  $Z_{S,opt} = f(f)$ ,  $V_{CE} = 2 \text{ V}$ ,  $I_C = 5 / 20 \text{ mA}$

**Electrical characteristics**

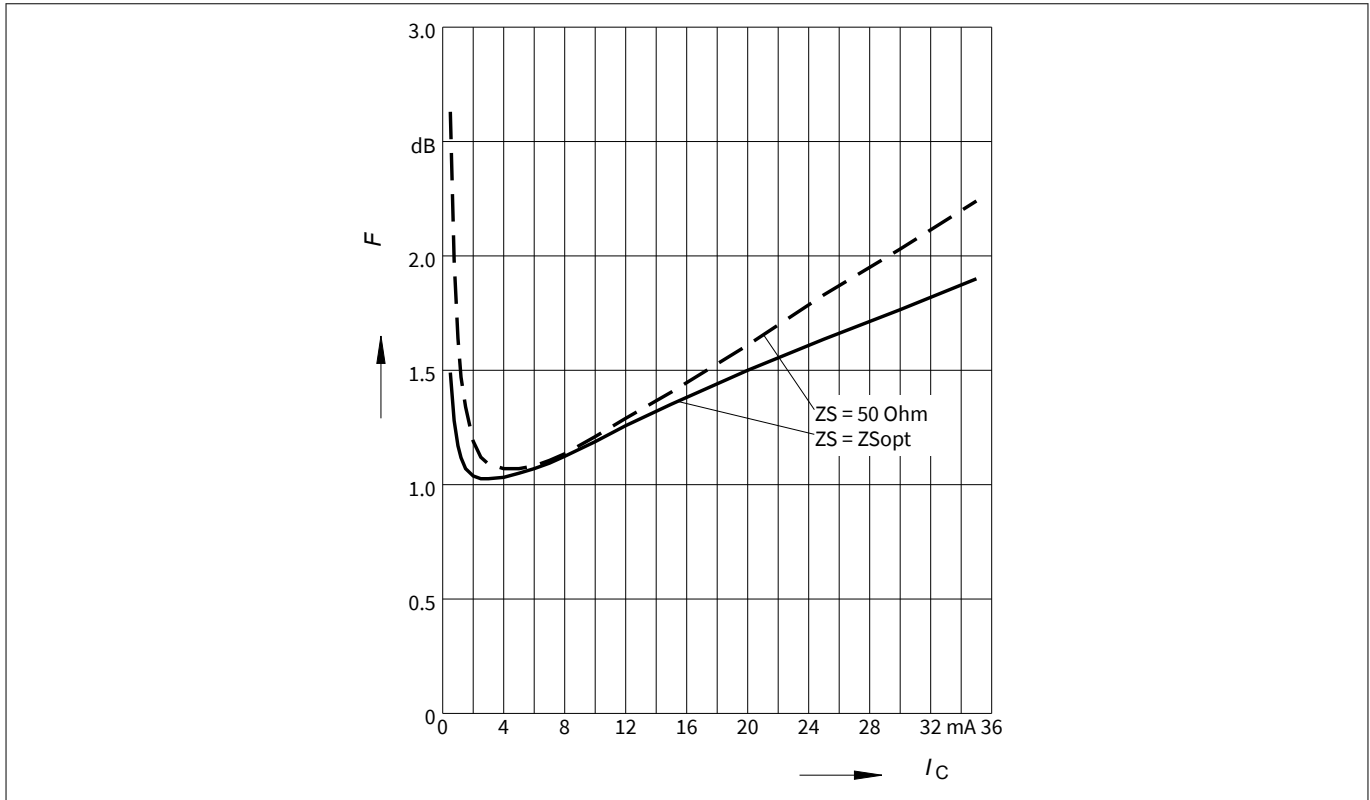


**Figure 17** Noise figure  $NF_{min} = f(f)$ ,  $V_{CE} = 2$  V,  $Z_S = Z_{S,opt}$ ,  $I_C = 5 / 20$  mA



**Figure 18** Noise figure  $NF_{min} = f(I_C)$ ,  $V_{CE} = 2$  V,  $Z_S = Z_{S,opt}$ ,  $f =$  parameter in GHz

**Electrical characteristics**

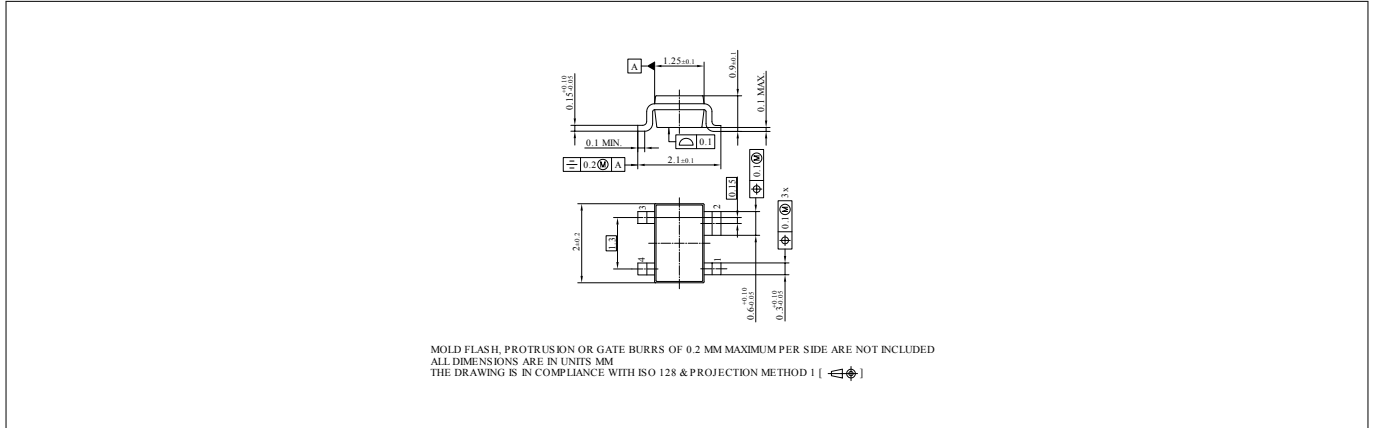


**Figure 19** Noise figure  $NF_{min} = f(I_C), Z_S = Z_{S,opt}, NF_{50} = f(I_C), Z_S = 50 \Omega, V_{CE} = 2 V, f = 1.8 GHz$

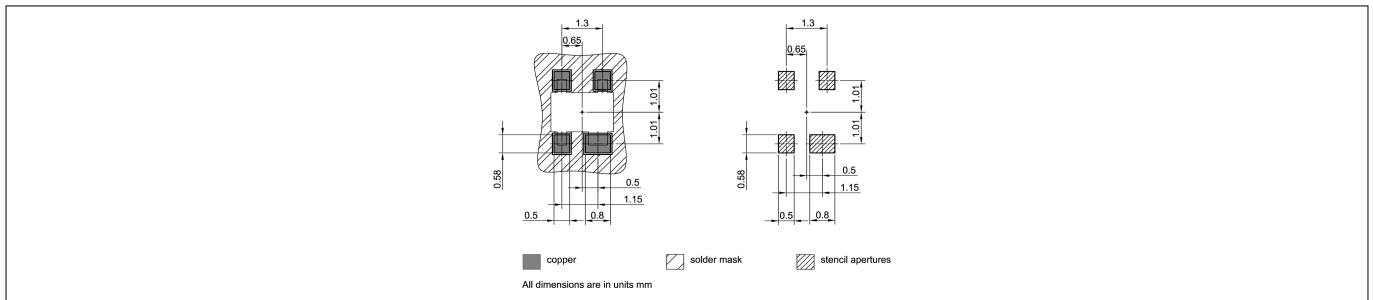
Note: The curves shown in this chapter have been generated using typical devices but shall not be considered as a guarantee that all devices have identical characteristic curves.  $T_A = 25 \text{ }^\circ\text{C}$ .

**Package information SOT343**

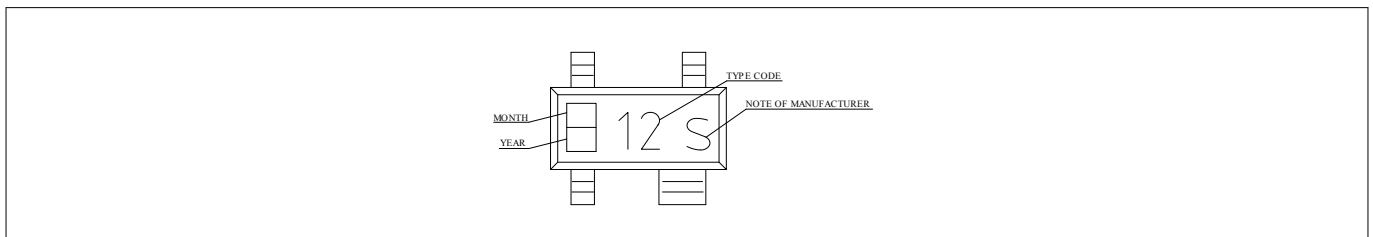
**4 Package information SOT343**



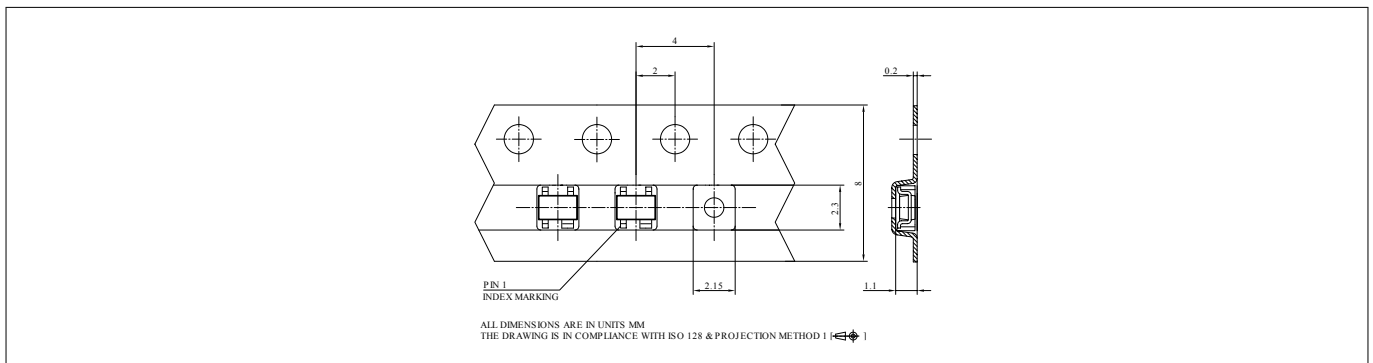
**Figure 20 Package outline**



**Figure 21 Foot print**



**Figure 22 Marking layout example**



**Figure 23 Tape dimensions**



---

Revision history

## Revision history

Document version	Date of release	Description of changes
Revision 2.0	2019-01-25	New datasheet layout, typical DC curves added.